

PAPER • OPEN ACCESS

CO₂ post-combustion capture in coal-fired power plants integrated with solar systems

To cite this article: R Carapellucci *et al* 2015 *J. Phys.: Conf. Ser.* **655** 012010

View the [article online](#) for updates and enhancements.

You may also like

- [Prediction of Coal-Fired Power Generation Cost](#)
Yixiao Wang
- [The burden of premature mortality from coal-fired power plants in India is high and inequitable](#)
Dweep Barbhaya, Vittal Hejjaji, Aviraag Vijayaprakash *et al.*
- [Satellite measurements oversee China's sulfur dioxide emission reductions from coal-fired power plants](#)
Siwen Wang, Qiang Zhang, Randall V Martin *et al.*



 The Electrochemical Society
Advancing solid state & electrochemical science & technology

250
ECS MEETING CELEBRATION

*Step into the
Spotlight*

**SUBMIT YOUR
ABSTRACT**

250th ECS Meeting
October 25–29, 2026
Calgary, Canada
BMO Center

Submission deadline:
March 27, 2026

CO₂ post-combustion capture in coal-fired power plants integrated with solar systems

R Carapellucci ¹, L Giordano ², M Vaccarelli ^{1,*}

¹ Department of Industrial and Information Engineering and Economics, University of L'Aquila (Italy), Via Giovanni Gronchi 18, 67100 L'Aquila

² Laboratoire Réactions et Génie des Procédés (LRGP) (UMR 7274) Université de Lorraine, ENSIC, 1, rue Grandville - BP 20451.54001 Nancy Cedex, France

* Corresponding author E-mail:mauravaccarelli@gmail.com

Abstract. The majority of the World's primary energy consumption is still based on fossil fuels, representing the largest source of global CO₂ emissions. According to the Intergovernmental Panel on Climate Change (IPCC), such emissions must be significantly reduced in order to avoid the dramatic consequences of global warming. A potential way to achieve this ambitious goal is represented by the implementation of CCS (Carbon Capture and Storage) technologies.

However, the significant amount of energy required by the CCS systems still represents one the major barriers for their deployment. Focusing on post-combustion capture based on amine absorption, several interesting options have been investigated to compensate the energy losses due to solvent regeneration, also using renewable energy sources. One of the most promising is based on the use of concentrating solar power (CSP), providing a part of the energy requirement of the capture island.

In this study the integration of a CSP system into a coal-fired power plant with CO₂ post-combustion capture is investigated. Basically, a CSP system is used to support the heat requirement for amine regeneration, by producing saturated steam at low temperature. This allows to reduce or even eliminate the conventional steam extraction from the main power plant, affecting positively net power production and efficiency. The energy analysis of the whole system is carried out using the GateCycle software to simulate the coal-fired power plant and ChemCad platform for the CO₂ capture process based on amine absorption.

1. Introduction

Human activities, since the pre-industrial era, have contributed enormously to increase the overall level of greenhouse gas emissions in the atmosphere. According to the statistics of International Energy Agency, CO₂ emissions from fuel combustion have reached almost 32 Gt in 2012, corresponding to an year on year increase of around 1.2%. Electricity and heat generation have contribute to around 40% of such emissions, heavily relying on the use of coal, the most carbon-intensive fossil fuel [1].

The integration of technologies based on renewable energy into power generation system can offer the possibility to drastically reduce CO₂ emissions. Despite their huge potential, the use of renewable technologies is still hindered by their high capital costs and their low density and discontinuity, threatening the security and the reliability of supply [2]. In this context, CCS (Carbon Capture and



Storage) is regarded as an interesting option to obtain a short term reduction of CO₂ emissions, until renewable energies will reach the technical and economic feasibility.

Currently, amine-based post-combustion capture represents the most suitable technology for the retrofitting of existing power plants. Research efforts in this field are focused on reducing the considerable efficiency penalty and losses in power plant capacity, mainly arising by the need to extract a considerable fraction of medium-low pressure steam for the stripper reboiler heating.

Several solutions have been proposed, including the optimization of the operating parameters of absorber/stripper system, the modification of CO₂ scrubbing process and improvement of heat integration by modifying the original power plant layout [3].

An alternative option to mitigate performances penalties induced by the CO₂ capture island is the use of a solar thermal energy system, assisting the solvent regeneration process.

A few number of studies have addressed the integration of solar energy into power plants retrofitted with CO₂ capture. The concept was first proposed by Wibberley et al. [4], to study the retrofit of a coal-fired power plant. They investigated the partial replacing of steam extraction with steam generated by a solar collector field, observing a considerable reduction of power plant derating. Later Cohen [5] carried out a preliminary study of supplying the overall reboiler duty, by combining mid-to high temperature solar collectors with a molten salt thermal energy storage. Considering the same technology, Mokhtar et al. [6] evaluated the techno-economic feasibility of solar assisted post-combustion capture, using actual weather and wholesale electricity price data to assess the impact of regional and climatic variables. Considering a 600 MW coal-fired power plant with a 80% CO₂ capture rate, Zhao et al. [7] compared, from the energy point of view, solar assisted solvent regeneration with the solar feed-water repowering operated through the closure of high pressure steam bleedings.

This paper aims to investigate several options to retrofit a coal-fired power plant with a MEA-based absorption system, capturing 90% of CO₂ from exhaust flue gas.

Assuming a conventional steam extraction to provide heat for solvent regeneration, the study first assesses the potential reduction of power losses attainable by operating the coal fired power plant to various degrees of high-pressure steam turbine overload. The retrofit options based on steam extraction are then compared with the case of integrating a CSP system, providing part of steam for the stripper reboiler operation. The performance improvement of hybrid system is assessed, evaluating the range of efficiency and power production increase on a mean seasonal and annual basis.

2. Model of the solar field

A linear Fresnel collector with direct steam generation has been selected as reference technology for the solar field. Performances have been evaluated based on technical specifications of a commercially available solar collector of Novatec Solar technology [8], NOVA-1. The solar field involves the use of several base modules connected in series in order to obtain a solar collector with the required temperature increment. Besides, the required steam flow rate is attained by connecting in parallel several solar collectors.

Figure 1 shows a vertical cross-section of the base module, while Table 1 summarizes the product data sheet.

Neglecting the power losses from the receiver, the thermal power output of the solar collector is the product of primary reflector surface, Direct Normal Irradiation (DNI) and the optical efficiency

$$P_{th} = A \cdot (DNI \cdot \eta_{opt} - P_{loss}) \quad (1)$$

The specific thermal loss of primary reflector is calculated as

$$P_{loss} = u_0 \Delta T + u_1 \Delta T^2 \quad (2)$$

where $u_0 = 0.056 \text{ W}/(\text{m}^2\text{K})$ and $u_1 = 0.000213 \text{ W}/(\text{m}^2\text{K}^2)$.

Finally, the optical efficiency is evaluated by multiplying the baseline value ($\eta_0 = \eta(\Theta_{\perp} = \Theta_{\parallel} = 0) = 0.67$) by the transversal $K_{\perp}(\Theta_{\perp})$ and longitudinal $K_{\parallel}(\Theta_{\parallel})$ correction factors:

$$\eta_{\text{opt}} = \eta_0 \cdot K_{\perp}(\Theta_{\perp}) \cdot K_{\parallel}(\Theta_{\parallel}) \quad (3)$$

Table 2 summarizes the thermal power output of the solar collector under reference conditions.

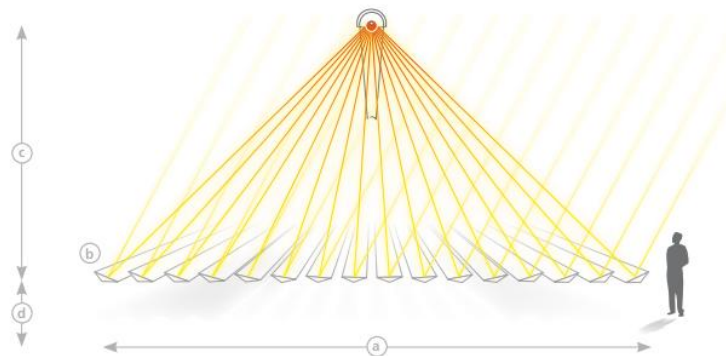

Figure 1 Cross section view of the base module [8]

Table 1 Technical data of the base module[8]

<i>Geometrical parameter</i>	<i>Value</i>
Width (a)	16.56 m
Length (b)	44.8 m
Absorber tube height above primary reflector level (c)	7.4 m
Height of primary reflector level (d)	0.75 – 1.05 m above ground level
Recommended minimum clearance between parallel rows	4.5 m
Aperture surface of primary reflectors	513.6 m ²
Orientation	±20° longitudinal deviation from north-south axis
Minimum row length	5 modules, 224 m in length
Maximum row length	22 modules, 985.6 m in length

2.1. Site characterization

In order to assess the feasibility of integrating a CSP system into a coal fired power plant with CO₂ capture based on amine absorption, a potential installation in a site of the south of Italy (Brindisi) has been considered.

The availability of solar energy source and the air temperature have been evaluated on a hourly basis, using a software developed at the Department of Mechanical, Energy and Management Engineering (University of L'Aquila), as a part of a doctoral thesis [9].

In this respect, Figure 2 shows the monthly values of solar radiation incident on a horizontal surface for the site of interest.

Table 2 Thermal output under reference conditions [8]

<i>Reference conditions</i>	
External temperature=	40°C
Inlet flow temperature=	100°C
Outlet flow temperature=	270°C
No wind	
900 W/m ² direct normal radiation	
30° transversal angle Θ_{\perp}	
10° incidence angle Θ_{\parallel}	
<i>Performance</i>	
278 kW per control unit	
541 W/m ² of aperture surface	
area for primary reflectors	

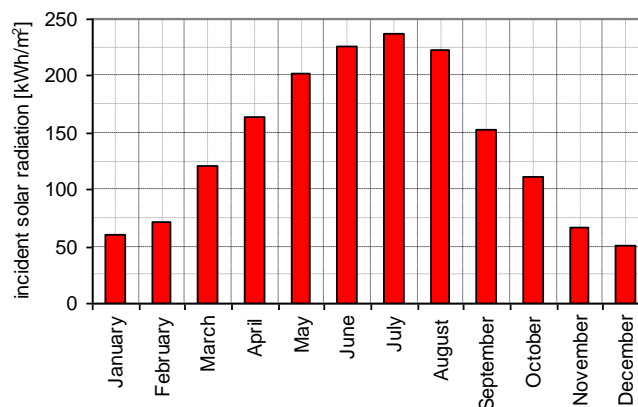

Figure 2 Monthly values of monthly solar radiation on a horizontal surface in the city of Brindisi

For the purposes of designing a concentrating solar power plant, the information of greatest interest is related to the direct radiation on a normal surface to the Sun (DNI, Direct Normal Irradiation), being such systems unable to collect the diffuse component.

Conventionally, the design of CSP systems is based on the radiation detected on June 21 at 12:00, or at the summer solstice. In this study, a radiation of 870 W/m² has been considered, being representative of the highest values of DNI for the site of Brindisi; moreover, it has been assumed a solar height of 77.8° (maximum solar height of 21 June), an azimuth angle of zero (solar noon), and an ambient air temperature of 30°C.

In order to assess the variation of CSP performances, due to the daily fluctuation of solar energy source, hourly data have been properly averaged on a seasonal and annual basis. Hence, five diurnal profiles of DNI and air temperature have been evaluated, four representative of a typical day of each season and one describing the mean annual daily behavior.

With respect to the city of Brindisi, Figure 3 shows the summer, winter and annual diurnal profiles of DNI, while Table 3 summarizes the overall daily radiation of typical days and the corresponding average air temperature.

Table 3 Solar insolation data in typical days

Typical day	Period	Day numbers	Daily radiation (kWh/m ²)	Average temperature (°C)
Winter	I trimester	90	2.82	10.31
Spring	II trimester	91	6.51	17.93
Summer	III trimester	92	6.66	23.82
Autumn	IV trimester	92	2.49	14.44
Year	year	365	4.63	16.66

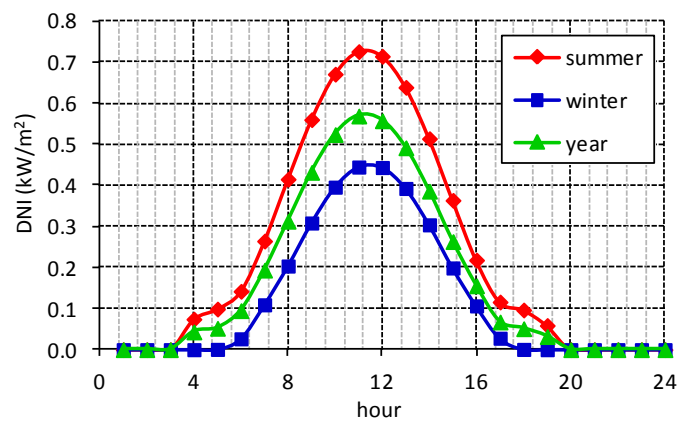

Figure 3 Summer, winter and annual diurnal profiles of DNI

3. Energy analysis of integrating a CSP system into a coal fired power plant with CO₂ capture

The study investigates the retrofit of a coal-fired power plant with a post combustion capture system based on MEA absorption. At first, several options to provide heat to the reboiler through the steam extracted from the main plant are compared. Then, the integration of a CSP system providing part of steam for solvent regeneration is analyzed, with the aim to assess the potential improvement of energy performances.

3.1. Retrofit options based on conventional steam extraction

Figure 4 shows the layout of coal fired-power plant, modeled using the GateCycle software [10]. At design conditions, it produces a net power output of 100 MW, with a LHV efficiency of 42%.

Post-combustion capture of CO₂ is accomplished by a chemical absorption system using monoethanolamine (MEA) as solvent. The CO₂ capture island has been simulated using the software ChemCAD 6.3, by Chemstations [11]. Assuming a capture ratio (ϕ) of 90% and a lean loading of 0.25 kg_{CO2}/kg_{MEA}, the specific reboiler duty states at 3.5 MW/kg_{CO2} [12], corresponding to a thermal power requirement for solvent regeneration of around 65.7 MW_{th}. This thermal power can be provided using saturated steam at about 3 bar.

Table 4 allows to compare the coal-fired power plant energy performances at design conditions (*Case 0*) and after CO₂ capture retrofit, assuming that the heat duty for amine regeneration is fully met by extracting steam at crossover pipe between the intermediate and low pressure steam turbines.

Two retrofit options have been investigated, operating the steam power plant at off-design without (*Case 1*) or with (*Cases 2 and 3*) high-pressure overload. Assuming the same fuel flow rate of design

conditions (*Case 1*), that is avoiding an overload of the high pressure steam turbine, the steam extracted along the expansion for solvent regeneration produces a significant derating of the coal-fired power capacity, that reduces from 100 to 79.1 MW (-21%), the electricity consumption of CO₂ capture and compression processes accounting for 35% ($P_{CO_2\text{ CAPT\&COMPR}}=7.4$ MW). As a result, the efficiency reduces to 33.1%, corresponding to an efficiency penalty of around 9% pts.

In *Case 2*, the coal flow rate has been properly increased in order to produce an overload at high-pressure steam turbine of 10%. Hence, with the same steam extraction of *Case 1* (25 kg/s), the power plant derating reduces to 16% (84.0 MW), while the net efficiency remains almost unchanged.

Considering the maximum capability of boiler [13] and steam turbine [14,15] compared to the design rating, the HPST overload has been increased up to a maximum value of 15% (*Case 3*). Hence, the power plant capacity reaches 85.5 MW, against a slight decrease of net efficiency, that states at 32.9% (- 9% pts). With a capture ratio of 90%, specific CO₂ emissions reduces from 752 kg/MWh to less than 96 kg/MWh.

Comparing the retrofit options, it is noted that *Case 2* allows to provide a good compromise between net power output of the steam power plant with CO₂ capture and the overload of its high pressure turbine. Hence, the integration of CSP system will be investigated with reference to a steam power plant operating at off-design conditions with a 10% HPST overload.

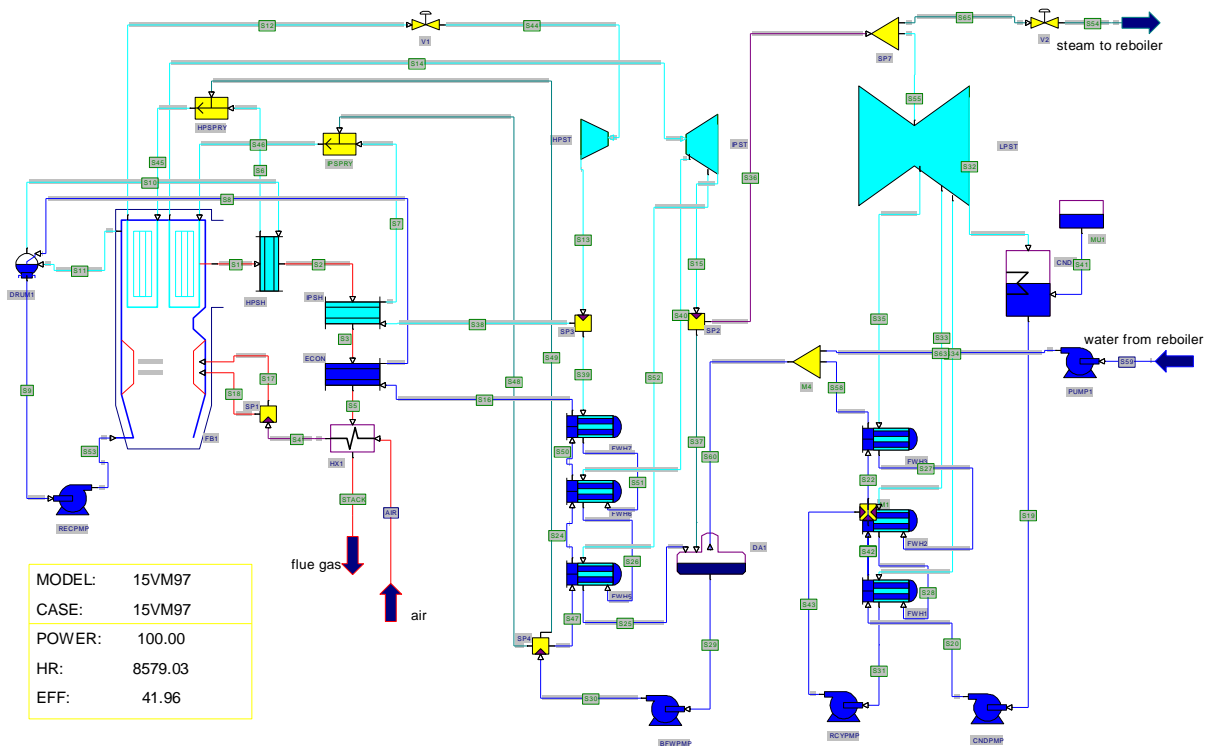

Figure 4 Layout of pulverized coal-fired power plant

3.2. Retrofit options based on CSP system integration

As outlined in paragraph 2, the CSP system based on linear Fresnel technology has been sized considering the greatest DNI achieved all year round (June 21 at 12:00: DNI=870 W/m²). In this regard, Table 5 summarizes the main project and performance parameters of the solar field, while

Figure 4a shows the trend of steam flow rate production in typical days of summer and winter, as well as the mean annual diurnal trend.

Table 4 Energy performance of the power plant integrated with the CO₂ removal system

	Case 0 On-design $\varphi = 0\%$	Case 1 Off-design $\varphi = 90\%$	Case 2 Off-design $\varphi = 90\%$	Case 3 Off-design $\varphi = 90\%$
High pressure overload	0%	0%	+10%	+15%
P_{NET} [MW]	100.0	79.1	84.0	85.5
$P_{CO_2\ CAPT\ \&\ COMPR}$ [MW]	-	7.4	7.8	7.9
η_{NET} [%]	42.0	33.1	33.0	32.9
$CO_{2, em}$ [kg/s]	20.9	2.1	2.2	2.3
$CO_{2, em}$ [kg/MWh]	752.0	95.3	95.5	95.8
m_{FUEL} [kg/s]	9.4	9.4	10.0	10.2
m_{SH} [kg/s]	79.3	79.3	87.2	91.1
m_{RH} [kg/s]	74.8	74.7	81.7	84.7
m_{CD} [kg/s]	55.0	33.1	37.8	39.8
p_{CD} [kPa]	5.0	4.4	4.5	4.6
$m_{steam\ to\ reb}$ [kg/s]	-	24.9	24.9	24.9

Table 5 Main project and performance parameters of the solar field [16]

Modules in series by line	10
Line length [m]	448
Line width [m]	16.56
Line area catchment [m ²]	5136
Line temperature input [°C]	110
Line temperature output [°C]	140
Available solar power [kW]	2795.7
Power lost [kW]	37.2
Line net power output [kW]	2758.5
Number of Lines	24
Total power solar field [MW]	66.2
Net efficiency solar field [%]	61.7
Available steam flow [kg/s]	29.1

The steam available from the solar field, produced at 133°C and 3 bar, allows to reduce the steam extraction from the main plant. In this respect, Figure 4b shows the effect of CSP system integration on steam extraction, assuming an HPST overload of 10%.

As expected, the steam extraction achieves the highest value (25 kg/s) at night, due to the lack of solar energy source, while it progressively decreases with the increase of solar energy availability. During the day, the total steam flow requirement is slightly higher than in the night, due to the lower valuable thermodynamic properties of solar steam production with respect to steam extracted from the turbine of the power plant. During summer the solar field is able to produce almost all the steam required by the reboiler in the middle of the day (24.1 kg/s at 11:00). Hence, the corresponding steam extraction

from the main power plant reaches a minimum value of 4.2 kg/s (Table 6). Otherwise, during winter, the CSP system reaches a maximum steam production of 14.5 kg/s, thus requiring a steam extraction of 12.4 kg/s.

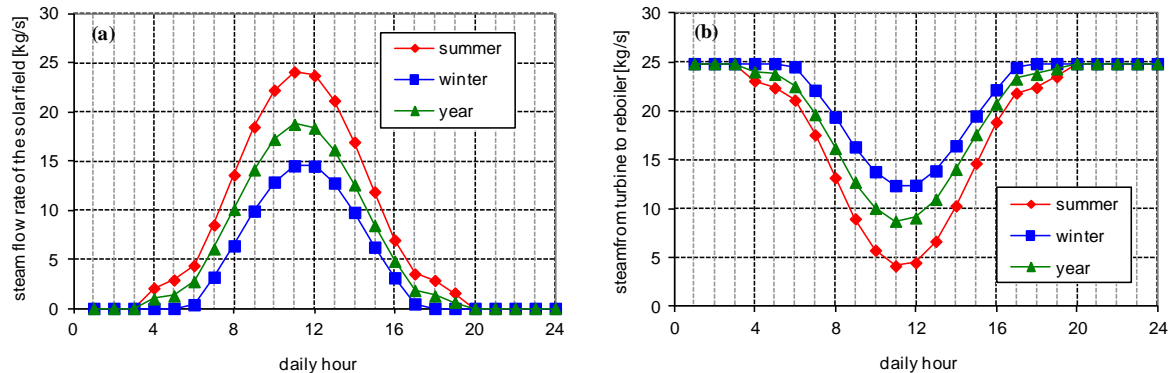

Figure 5 Steam flow production of solar field and corresponding steam extraction from the power plant for typical days of summer and winter and mean annual diurnal trend

Figures 6 and Table 6 show the effect of CSP system integration on the energy behavior of the retrofitted coal-fired power plant. Due to the solar thermal power production, the net power plant capacity reaches a maximum value of 95.1 MW in the middle (11:00) of a typical summer day, thus decreasing the capacity derating to less than 5% pts. Moreover, Figure 6d shows that, due to the off-design operating conditions of HPST ($m_{HPST}=+10\%$), LPST operates with a slight overload (about +2%), in the case of minimum steam extraction (4.2 kg/s).

On the other hand, during winter, the power plant derating remains lower than the case of steam extraction only, reaching in the middle of day a minimum value of -10% (90.2 MW) (Table 6).

It is also noteworthy to note that, due to the steam extraction at crossover pipe between IPST and LPST sections, the steam sent to condenser, as well as its operating pressure, reduces compared to design conditions. In this regard, Figure 6c shows that such deviation decreases with the rise of the solar steam contribution, being entirely eliminated in the middle of a typical summer day.

As regard to the net efficiency, the maximum values range between 35.5% (winter) up to 37.4% (summer), corresponding to an efficiency penalty of 6 and 5% pts (Fig. 6b). As a result, the specific CO_2 emissions further decrease, reaching a minimum value of 77.8 kg/MWh.

Figure 7a shows that integrating the CSP system also produces an increase of the average daily net plant efficiency, corresponding to 0.7% pts in winter and 1.4% pts in summer. Moreover, the increase of the average daily electricity production reaches around 2.9% on annual basis (Fig. 7b).

Table 6 Energy results of the integration

	Off-design $\varphi = 90\%$ Steam extr.	Off-design $\varphi = 90\%$ Steam extr. + CSP summer	Off-design $\varphi = 90\%$ Steam extr + CSP winter
P_{NET} [MW]	84.0	95.1	90.2
$P_{CO_2\ CAPT\ \&\ COMP}$ [MW]	7.8	7.8	7.8
η_{NET} [%]	33.0	37.4	35.5
$CO_{2, em}$ [kg/MWh]	87.3	77.8	81.7
$m_{steam\ from\ CSP}$ [kg/s]	-	24.1	14.5
$m_{steam\ from\ extr}$ [kg/s]	24.9	4.2	12.4
LP overload [%]	-31.0	2.2	-11.1
HP overload [%]	10.0	10.0	10.0

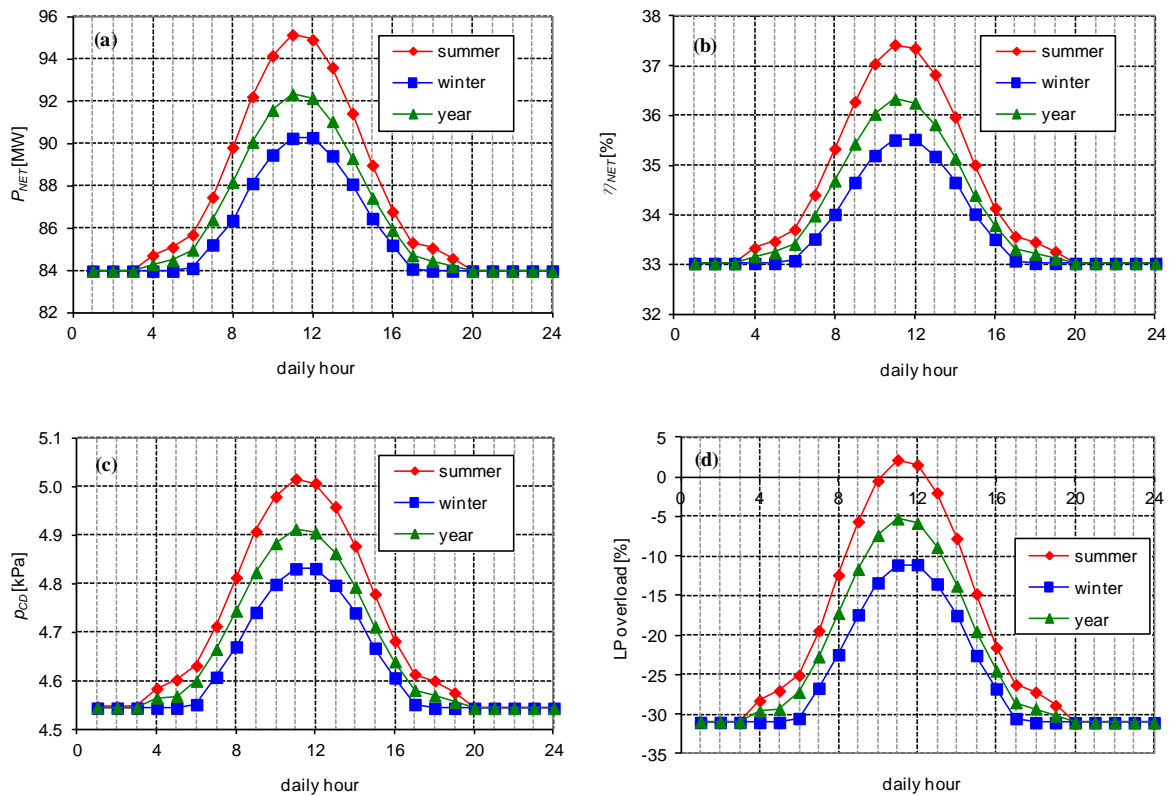

Figure 6 Trend of the net power output (a), net efficiency (b), condenser pressure (c) and LPST overload (d) for typical days of summer and winter and mean annual diurnal trend

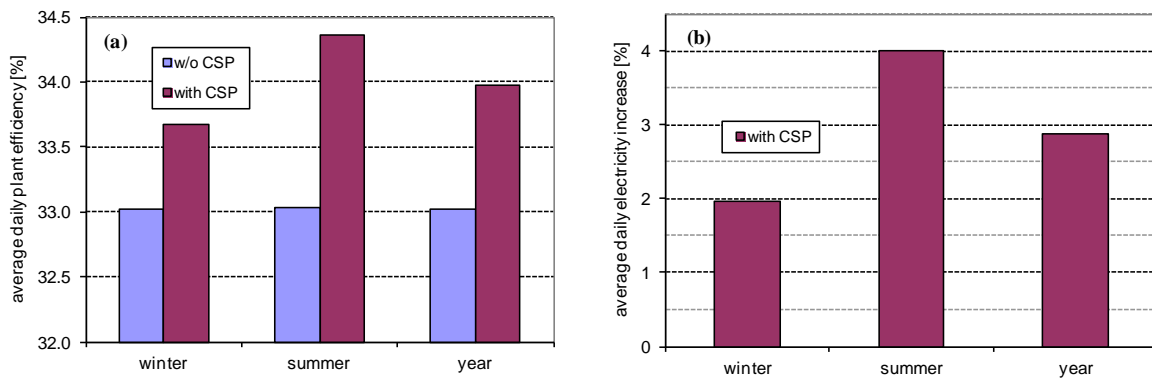

Figure 7 Average daily plant efficiency without and with CSP integration and increase in average daily electricity production thanks to the CSP integration

4. Conclusions

The aim of this paper has been the use of solar energy source in a coal-fired power plant retrofitted with a post-combustion amine-based CO₂ capture island. A concentrated solar collector based on Fresnel technology has been chosen as auxiliary unit, in order to provide a fraction of steam requirement for MEA regeneration.

The energy analysis has highlighted that CSP system enables to reduce the steam extraction from the

main plant, to an extent that depends on the availability of solar energy resource. The maximum solar steam production occurs in the middle of a typical summer day (11:00 a.m.), drastically reducing the steam extraction (-83%) compared to the retrofit plant without CSP system integration (25 kg/s). Conversely, during winter, the maximum contribution of solar energy source reduces to less than 50% of the overall steam requirement (26.9 kg/s).

As a result, performances of retrofitted power plant enhance compared to the case of steam extraction only. Assuming an HPST overload of 10%, the maximum power plant capacity states at 90.2 MW during a typical winter day, thus reducing the capacity derating from 16% to 10%; on the other hand, the net efficiency gains more than 5% pts, stating at 35.5%. Considering a typical summer day, the CSP system allows to reach in the middle of day a maximum power output of 95 MW, with a corresponding net efficiency of 37.4% and specific CO₂ emissions lower than 80 kg/MWh.

The improvement of energy performances is noticeable even on a mean daily basis. For instance, the increase of average daily net plant efficiency ranges from 0.7% pts (winter) up to 1.4% pts (summer). In addition, the mean annual increase of daily electricity production states at around 3%.

References

- [1] International Energy Agency (IEA) 2014 CO₂ emissions from fuel combustion - Highlights Paris.
- [2] Parvareh F, Sharma M, Qadir A, Milani D, Khalilpour R, Chiesa M, Abbas A 2015 Integration of solar energy in coal-fired power plants retrofitted with carbon capture: A review, *Renew Sust Energ Rev*, **48** 49-61.
- [3] Rubin E S, Mantripragada H, Marks A, Versteeg P, Kitchin J 2012 The outlook for improved carbon capture technology, *Progr Energ Combust*, **38** 630-671.
- [4] Wibberley L J, Scaife P 2008 Retro-fitting post combustion capture, Cooperative Research Centre for Coal in Sustainable Development (Australia), *Technology Assessment Report* **75**.
- [5] Cohen S M W M, Rochelle G T 2010 Utilizing solar thermal energy for solvent regeneration in post-combustion CO₂ capture, *ASME 4th International Conference on Energy Sustainability, Phoenix*.
- [6] Mokhtar M, Ali M T, Khalilpour R, Abbas A, Shah N, Hajaj A A et al 2012 Solar-assisted post-combustion carbon capture feasibility study, *Appl Energy*, **92** 668-76.
- [7] Zhao Y, Hong H, Zhang X, Jin H 2012 Integrating mid-temperature solar heat and post-combustion CO₂-capture in a coal-fired power plant, *Sol Energy*, **86** 3196-3204.
- [8] Novatec Solar 2010 Nova 1 - Turnkey solar boiler, mass produced in industrial precision, Novatec Solar GmbH, Karlsruhe.
- [9] Giordano L 2010 Studio ed ottimizzazione di un'isola energetica da fonti rinnovabili con sistema di accumulo ad idrogeno, PhD Thesis, University of L'Aquila.
- [10] General Electric Company 2005, GateCycle™, Getting started & installation guide, General Electric Company.
- [11] Chemstations, Process Flowsheet Simulator, User Guide Chemstations Inc., 2008, Houston, USA.
- [12] Vaccarelli M, Carapellucci R, Giordano L 2014 Energy and economic analysis of the CO₂ capture from flue gas of combined cycle power plants, *Energy Procedia*, **45** 1165-1174.
- [13] Collins G, Naval Engineering Plants, 2012, AuthorHouse (Bloomington).
- [14] Raja A K, Shriwastav A P, Dwivedi M, Power Plant Engineering, 2006, New Age international Ltd, Publishers (New Delhi).
- [15] Deidewig F, Wechsun M, Thermodynamic Aspects of Designing the New Siemens High Pressure Steam Turbine With Overload Valve for Supercritical Applications, *Proceedings of ASME 2006 Power Conference*.
- [16] Cau G, Cocco D, Tola V 2013 Analisi dell'integrazione di impianti di cattura post-combustione della CO₂ con fonti rinnovabili, ENEA - Ricerca di Sistema Elettrico.