



Produced water treatment using two-phase partitioning bioreactor

V. Piemonte, M. Prisciandaro, A. Cassese, L. Di Paola & D. Barba

To cite this article: V. Piemonte, M. Prisciandaro, A. Cassese, L. Di Paola & D. Barba (2016): Produced water treatment using two-phase partitioning bioreactor, Desalination and Water Treatment, DOI: [10.1080/19443994.2016.1148222](https://doi.org/10.1080/19443994.2016.1148222)

To link to this article: <http://dx.doi.org/10.1080/19443994.2016.1148222>



Published online: 12 Feb 2016.



Submit your article to this journal [↗](#)



View related articles [↗](#)



View Crossmark data [↗](#)



Produced water treatment using two-phase partitioning bioreactor

V. Piemonte^a, M. Prisciandaro^{b,*}, A. Cassese^a, L. Di Paola^a, D. Barba^a

^aFaculty of Engineering, University Campus Biomedico of Rome, Via Alvaro del Portillo 21, 00128 Rome, Italy

^bDepartment of Industrial and Information Engineering and of Economics, University of L'Aquila, Viale Giovanni Gronchi 18, 67100 L'Aquila, Italy, email: marina.prisciandaro@univaq.it

Received 29 May 2015; Accepted 25 January 2016

ABSTRACT

Produced waters (PW) are the largest waste associated to the production of oil and gas; they contain dissolved salts, oil (dissolved and scattered organic compounds), chemicals and salt intolerant additives to the oil well operations, suspended particles, sand and other compounds, making their treatment very tricky. In this paper, we propose the use of a two-phase partitioning bioreactor (TPPB) for the biological treatment of PWs. We model the application the TPPB on the stream after classical pre-treatment stages: the reactor functioning is based on the controlled release of substrate by means of a solvent. This study aims at developing a mathematical model for a TPPB adopting oleic alcohol (Adol 85 NF) as a solvent; we test its reliability by means of a sensitivity analysis, so to evaluate its efficiency for COD removal in a PW stream, aimed at water reuse.

Keywords: Produced water treatment; TPPB; Mathematical modelling; Bioreactor

1. Introduction

Produced water (PW) is the largest by-product, or waste, associated with the production of oil and gas. It is the water that, being trapped in underground formations, is brought up to the surface with the oil during the extraction process. Currently, it is treated and disposed off in deep wells on the onshore platforms or directly discharged into the sea. Specifically, about 65% of this water is re-injected into the well for pressure maintenance, 30% of total is injected into the deep well for final disposal in the case of proper aquifer conditions, whereas the remaining part is discharged directly to surface water [1].

Quality and the quantity of PW are mainly affected from extraction technology and reservoir characteristics [2]; generally, the PW amount accounts for around 70% of total oil production wastewaters volume. As for PW quality, salinity, dissolved oil and aromatic are often the constituents of concern. Salinity limits also misrepresent PW toxicity assessment as current regulatory test organisms are salt intolerant. Therefore, there is great need to develop cost-effective technology for desalination and to consider more salt tolerant toxicity test species. Typically, PW contains high concentrations of aromatic hydrocarbons e.g. benzene, toluene, ethylbenzene, xylene (BTEX), naphthalene, phenanthrene, dibenzothiophene (NPD) and polycyclic aromatic compounds (PAH) [3,4], minerals,

*Corresponding author.

Presented at EuroMed 2015: Desalination for Clean Water and Energy Palermo, Italy, 10–14 May 2015. Organized by the European Desalination Society.

radioactive substances, dissolved gases, scale products, waxes, micro-organisms and dissolved oxygen [5]. The salt concentration may range from a few to 300,000 mg L⁻¹; the total organic carbon (TOC) concentrations lie between 0 and 1,500 mg L⁻¹, while oil and gas (O & G) concentrations are comprised between 2 and 565 mg L⁻¹ [2].

Nowadays, as fresh water supply becomes increasingly scarce, PW can become an important water source after suitable treatment [6]. In addition, it is crucial to find new technologies aimed not only at environmental sustainability but also at complying with the regulations affecting oil and gas exploration. The permit limits of O & G for treated PW according to the United States Environmental Protection Agency regulatory are 29 mg L⁻¹ for a monthly average and 42 mg L⁻¹ for a daily maximum [7].

In order to specifically remove hydrocarbons from PW, biological, physical and chemical methods are available. In offshore extraction facilities, due to space constraints, compact physical and chemical treatment technologies mostly apply [8] (photo-electrocatalytic processes, hydrocyclones, coagulation and flocculation). Most of these techniques are only suitable for pretreatment of wastewater for *in situ* reuse, for example for reinjection to enhance oil recovery yield [2].

Biological treatments (secondary treatments) are based on the microbial degradation in aerobic conditions and have proved to be a good and efficient method to remove dissolved hydrocarbons (BTEX) in PW. The most commonly used biological treatments in wastewater treatments include activated sludges, the sequencing batch reactor (SBR) and the biological aerated filter (BAF). Among these systems, the SBR has proved to be the most effective method for the water purification from dissolved hydrocarbon compounds [2]; however, this applies only for concentrations of substrate (COD) below a given threshold, the efficiency dropping down for larger concentrations, due to a marked substrate inhibition.

In order to overcome this limitation, in this paper we explore the feasibility of a two-phase partitioning bioreactor (TPPB) based on the “controlled release” of substrate by means of the liquid–liquid equilibrium. Working as an SBR, it contains two phases: an aqueous phase, containing the biomass, and a second organic partitioning phase (an organic solvent or polymer beads). Organic compounds partitioned in the organic phase are gradually released into the aqueous phase, so as not to inhibit the biomass growth and activity (digestion of organic compounds).

This study focuses on modelling the TPPB to evaluate its performance and efficiency in COD removal in PW; the requirements are the COD concentration is 0.05 mg/L after treatment, thus allowing for its reuse.

2. Mathematical modelling

2.1. Process description

A PW, whose properties are reported in the first column of Table 1, has been adopted as reference for the inlet stream.

Analogously to a previous work of our group [9], the high BTEX concentration value complies with literature: the technical study of the International Association of Oil & Gas Producers [3] (OGP 2002), based on the analysis of data from 20 oilfields, sets the total BTEX content in the range 0.73–24.1 mg L⁻¹.

Fig. 1 reports the proposed process block scheme for PW treatment: a pretreatment of the PW is followed by the biological treatment in the TPPB. The properties of the stream out of the pretreatment stage have been computed elsewhere [9] and reported in Table 2 (second column). This stream is then directly fed to the TPPB.

Each bioreactor in the scheme is a TPPB. Fig. 2 shows a schematic representation of the two reactors (SBR and TPPB) during the reaction phase.

As we pointed above, TPBB is based on the “controlled release” of substrate, such that it works as

Table 1
BTEX composition

Component	Lower value (mg L ⁻¹)	Upper value (mg L ⁻¹)
Benzene	0.032	15.00
Toluene	0.055	5.85
Ethylbenzene	0.086	0.56
m-Xylene	0.258	1.30
p-Xylene	0.074	0.33
o-Xylene	0.221	1.66
Total BTEX	0.730	24.10

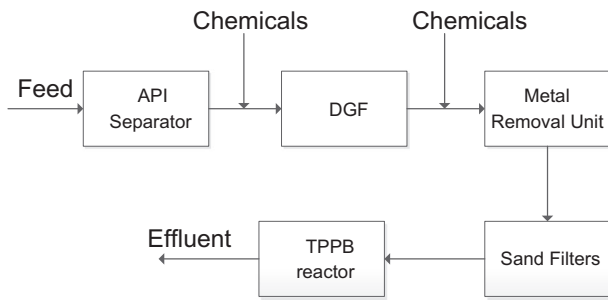

Fig. 1. Block scheme of the PW treatment.

a two-phase SBR: an aqueous phase containing the biomass, and an organic partitioning phase. Organic compounds are partitioned to the organic phase and then gradually released into the aqueous phase so as not to inhibit the biological reactions. Therefore, even in the case of high organic loads, micro-organisms are exposed to low substrate concentrations optimal for the reaction rate.

2.2. Reactors modelling

In the following, we briefly sketch a modelling description of the TPPB reactor. A more detailed analysis can be found elsewhere [10,11].

The xenobiotic degradation rate was modelled by the Haldane equation to describe the substrate inhibited kinetics:

$$r_s = v_{\max} \frac{C}{C + K_s + \frac{C^2}{K_I}} = K_{\max} \times X \frac{C}{C + K_s + \frac{C^2}{K_I}} \quad (1)$$

where X and C are the biomass and substrate concentration, respectively, K_s is the saturation constant and K_I is the inhibition constant, K_{\max} stands for the maximum removal rate.

The Haldane equation has been recast to reveal parameters more descriptive of the process kinetics [12]:

$$r_s = k_{\max} \cdot X(2 + \beta) \frac{C/C^*}{1 + \beta(C/C^*) + (C/C^*)^2} \quad (2)$$

where $C^* = \sqrt{K_s \cdot K_I}$ is the substrate concentration at which the maximum removal rate occurs and $\beta = \sqrt{K_I/K_s}$ accounts for the substrate inhibition.

To model the two-phase system, we accounted for substrate mass balance in both phases (Eqs. (3) and (4)), the kinetic equation and the substrate transfer (see Fig. 2).

We assumed a uniform, mean substrate concentration in the organic phase of the TPPB and the corresponding transfer rate is described in terms of an overall mass transfer coefficient.

$$\frac{dC_w}{dt} = aK_{ws} \left(\frac{C_{\text{org}}}{P} - C_w \right) - r_s \quad (3)$$

$$\frac{dC_{\text{org}}}{dt} = -\frac{V_w}{V_{\text{org}}} aK_{ws} \left(\frac{C_{\text{org}}}{P} - C_w \right) \quad (4)$$

Biomass mass balance is computed by:

$$\frac{dX}{dt} = r_X \quad \text{with } r_X = Yr_s - bX \quad (5)$$

Oxygen mass balance in the aerobic reactor is written as:

$$\frac{dC_{O_2}}{dt} = aK_{O_2}(C_{O_2}^* - C_{O_2}) - r_{O_2} \quad (6)$$

with $r_{O_2} = (1 - Y)r_s + bX$

where V_w is the aqueous phase volume; V_{org} is the organic phase volume; C is the substrate concentration; C_{O_2} is the oxygen concentration in the aqueous phase; $C_{O_2}^*$ is the oxygen concentration in equilibrium with gas bulk phase; K_{ws} stands for substrate mass transfer coefficient; a is the specific surface area

Table 2
PW composition

Component	Influent stream (mg L ⁻¹)	TPPB inlet (mg L ⁻¹)
Oil and grease	565	<10
Total suspended solid (TSS)	1,000	<0.1
Chemical oxygen demand (COD)	3,000	2,300
Biochemical oxygen demand (BOD)	1,500	1,100
Total organic carbon (TOC)	1,500	1,500
BTEX	20	20
Total dissolved solid (TDS)	37,500	35,000

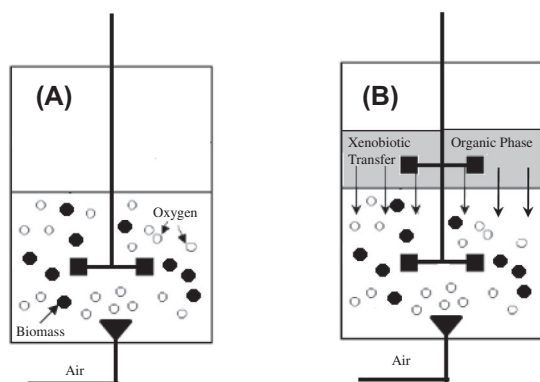

Fig. 2. Schematic representation of the SBR (A) and TPPB (B) reactors during the reaction phase.

referring to the aqueous phase; P stands for the partition coefficient; r_s is the substrate degradation rate; r_{O_2} is the oxygen uptake rate; r_x stands for the biomass growth rate; Y is the biomass yield coefficient; b is the endogenous respiration constant; K_{O_2} stands for the oxygen mass transfer coefficient. Subscripts w and org are for the aqueous and organic phases, respectively.

2.3. Model parameters

Table 3 reports the partition coefficients and costs for several organic solvents with respect to BTX compounds. As suggested by Collins and Daugulis [13], Adol 85 NF solvent realizes a good trade-off between cost, biocompatibility and selectivity; therefore, we adopted it in the process simulation as partitioning phase in the TPPB reactor.

Finally, Table 4 shows the model parameters used in the process simulation. We identified benzene as

Table 4

Model parameters (Tomei et al. [11]; Annesini et al. [10])

Parameter	Value
K_{max} (h^{-1})	0.05
aK_{ws} (h^{-1})	2.5
aK_{O_2} (h^{-1})	20
Y	0.67
P	161
b (h^{-1})	0.0001
X_0 (mg/L)	1,000
$C_{O_2}^*$ (mg/L)	1.5
K_I (mg/L)	100
K_S (mg/L)	30
V_w (L)	10
V_{org} (L)	2

key component to evaluate the reactor performance, since it is the most soluble (in water) xenobiotic component present in the PW and that with the higher inhibition influence on biomass. We chose *Pseudomonas Putida* as biomass, since it is tolerant to salt concentrations tested in this work.

3. Results and discussion

In order to test the model reliability, we performed a sensitivity analysis on key model parameters affecting the reactor performance. Fig. 3 reports the kinetics of xenobiotic removal in the aqueous phase at different initial concentration of the key component: an increase in the xenobiotic initial concentration reduces the reactor removal efficiency, even if biomass digests almost all the xenobiotic in the aqueous phase in one hour.

It is important to point out that the xenobiotic concentration in the aqueous phase is not a clear index of reactor removal capacity: from Fig. 4 it is evident that after 1 h almost all the xenobiotic loaded in the reactor

Table 3

Organic solvent for TPPB reactor (Collins and Daugulis [13])

Solvent type	P (Benzene)	P (Toluene)	P (Xilene)	Cost (\$/L)
Adol 85 NF	161	405	524	33
Dipentyl ether	365	473	781	781
Ethyl heptanoate	743	2,874	3,463	88
1-Decyne	427	1,587	NA	1,776
Jasmone	306	1,240	1,770	1,474
2-Decanol	94	745	NA	1896
2-Decanone	210	1,384	1896	990
2-Undecanone	205	1,304	1883	61

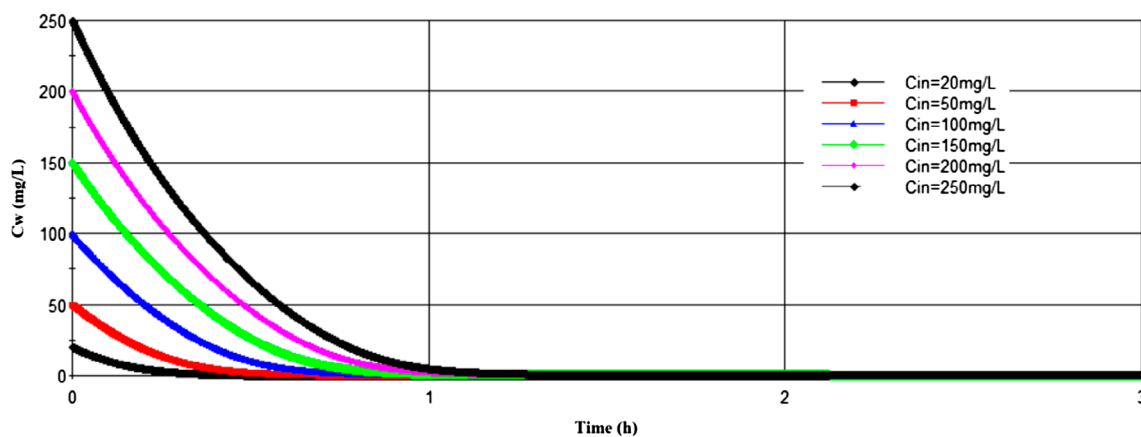

Fig. 3. Influence of initial xenobiotic concentration in the water phase (C_{in}) on reactor removal performance.

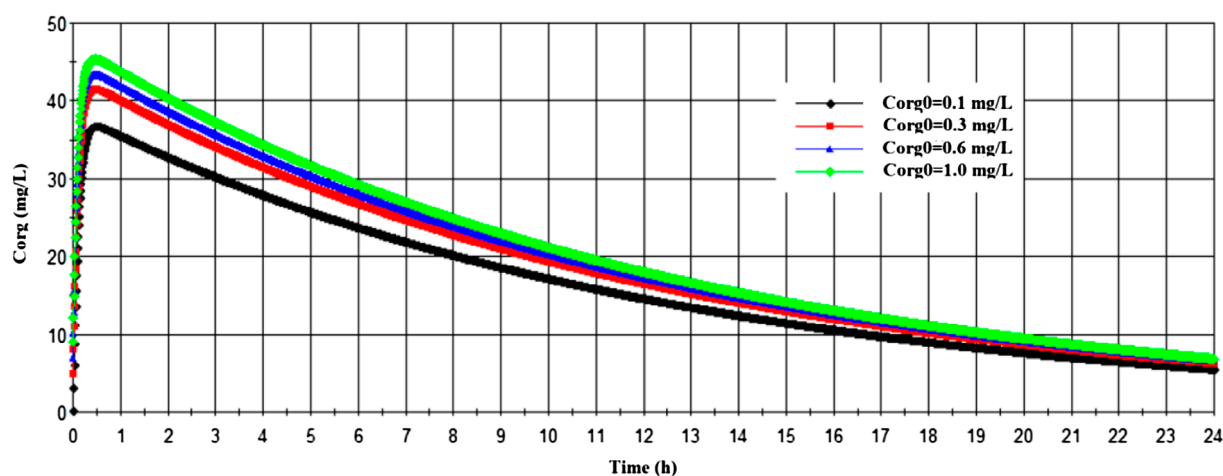

Fig. 4. Influence of initial xenobiotic concentration in the organic phase (C_{org0}) on reactor removal performance.

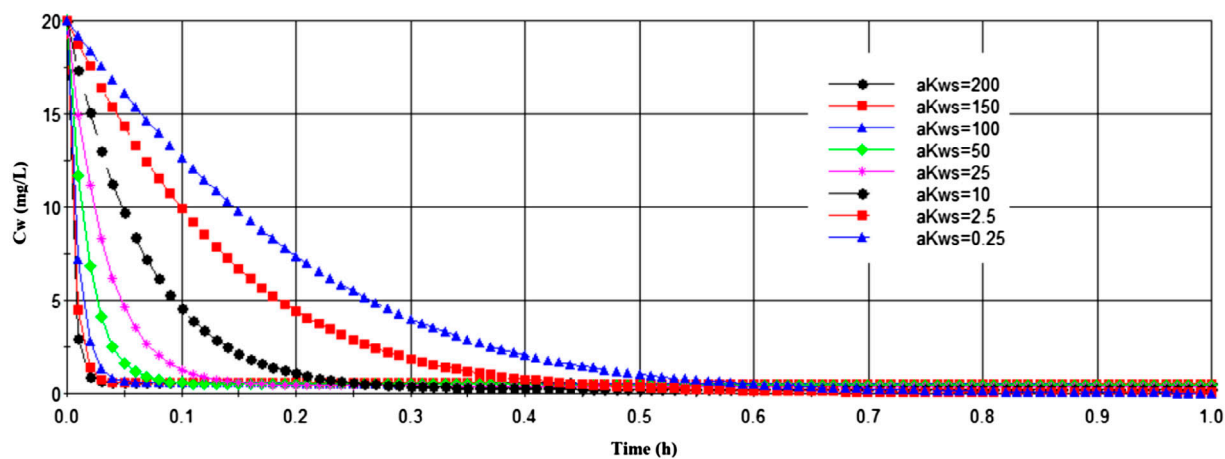

Fig. 5. Influence of xenobiotic mass transfer coefficient between organic and water phases on reactor removal performance.

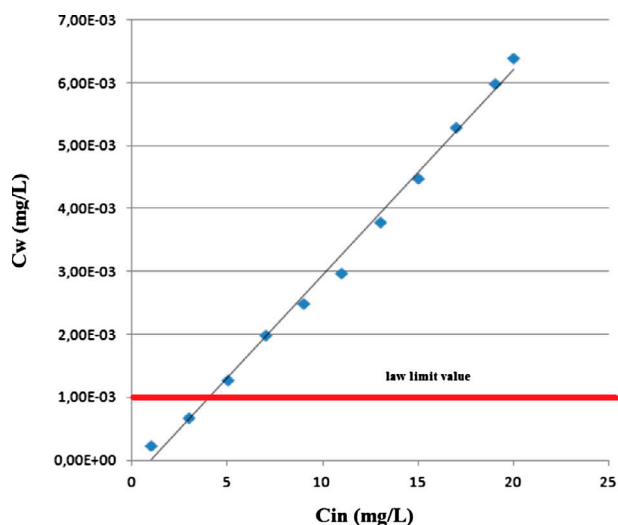

Fig. 6. Benzene concentration in the water phase in the outlet reactor stream for different initial benzene concentration in the reactor. Comparison with law limit concentration (0.001 mg/L) of benzene for agricultural water purpose.

is still stored in the organic phase, which slowly releases the compound in the aqueous phase. In other words, in the conditions tested, the characteristic time related to xenobiotic transfer between the two phases ($1/aK_{ws}$) is much higher than the reaction characteristic time in the liquid phase ($1/K_{max}$). Therefore, the reactor removal capacity is strongly affected by the

overall xenobiotic transfer coefficient. Fig. 5 shows the effect on an increase in aK_{ws} on the xenobiotic removal in the aqueous phase: low values of aK_{ws} determine a non-reliable course of the TPPB reactor.

The developed mathematical model has been used to evaluate the process reliability to treat PW for agricultural purpose. With reference to benzene as key component, Fig. 6 highlights the proposed process is able to meet the law requirement only for low benzene concentrations in the inlet stream to bioreactor.

4. Scaling-up

Once the parameters and operating conditions are set, we were able to test the feasibility of this system on an industrial scale to treat a flow rate of 100 m³ of PW a day.

Fig. 7 shows the process scheme of the proposed treatment: PWs, after a pretreatment step, enter a sequence of two reactors in parallel, both with a volume of about 56 m³, parted into 50 m³ of aqueous phase and 5 m³ of organic phase, with a gaseous volume (air) of 1 m³. The two reactors are fed in parallel with water and solvent streams, and with the inoculum. The water flow rate is approximately 50 m³/h. For both reactors conditions of perfect mixing are realized, with agitator speed of about 300 min⁻¹. The air required for the aerobic degradation by micro-organisms is bubbled into the reactors, to reach concentrations of dissolved oxygen around 2 mg L⁻¹.

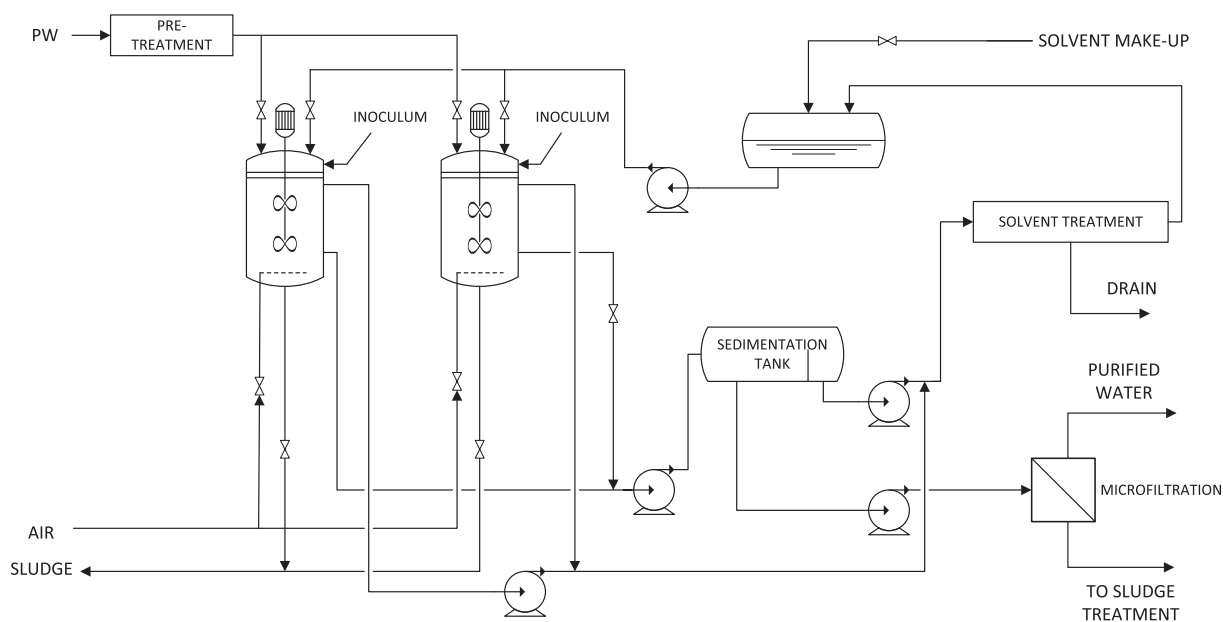

Fig. 7. PW treatment: process scheme.

For this system, it was decided to use two-stage reactors, with an organic phase dispersed in an aqueous phase: in this way the specific surface greatly increases, improving the transfer and, consequently, the process efficiency. After the filling phase (about 1 h), the step of reaction (24 h) and the settling phase, water is withdrawn from the reactor and sent to a sedimentation tank, where it is separated from the solvent. The water out stream from the sedimentation tank is then sent to a microfiltration unit, for a further purification; the permeate is purified water, while the retentate is sent to the sludge treatment. Part of the solvent used for this operation, after being separated from the water in the sedimentation, will be combined with another current that taken directly from the reactor; the sum of these two currents (solvent) is sent to a unit for processing (regeneration) of the solvent; subsequently, the solvent stream is stored in a tank, together with a make-up stream.

5. Conclusions

This work provides a model to evaluate the efficiency in COD removal of a TPPB when applied to a PW treatment.

The simulation results suggests the great potentiality of this biotechnological solution for the waste waters reuse, with a specific application for PWs.

Biotechnology processes promise to be of a great impact in the future as for wastewater treatment, since they rely on devices operating at mild conditions. On the other hand, they require a great care in control, which must rely on correct modelling, providing the mathematical framework for a successful control strategy.

In the future, we devise to cross experimental data with modelling to validate model hypotheses and provide a more reliable base for systems scale-up in the perspective of industrial applications.

References

- [1] M. Çakmakci, N. Kayaalp, I. Koyuncu, Desalination of produced water from oil production fields by membrane processes, *Desalination* 222 (2008) 176–186.
- [2] A.R. Pendashteh, A. Fakhru'l-Razi, T.G. Chuah, A.B. Dayang Radiah, S.S. Madaeni, Z.A. Zurina, Biological treatment of produced water in a sequencing batch reactor by a consortium of isolated halophilic microorganisms, *Environ. Technol.* 31 (2010) 1229–1239.
- [3] OGP—International Association of Oil & Gas Producers, Aromatics in produced water: Occurrence, fate and effect, and treatment, Report No. I (20/324) (2002).
- [4] T.I.R. Utvik, Chemical characterisation of produced water from four offshore oil production platforms in the North Sea, *Chemosphere* 39 (1999) 2593–2606.
- [5] E.T. Igunnu, G.Z. Chen, Produced water treatment technologies, *Int. J. Low-Carbon Technol.* 10 (2012) 1–21.
- [6] A. Di Zio, M. Prisciandaro, D. Barba, Disinfection of surface waters with UF membranes, *Desalination* 179 (2005) 297–305.
- [7] USEPA, 1996. Available from: <<http://nepis.epa.gov/Exe/ZyPURL.cgi?Dockey=20003615.txt>>.
- [8] F.R. Ahmadun, A. Pendashteh, L.C. Abdullah, D.R.A. Biaka, S.S. Madaeni, Z.Z. Abidin, Review of technologies for oil and gas produced water treatment, *J. Hazard. Mater.* 170 (2009) 530–551.
- [9] V. Piemonte, M. Prisciandaro, L. Mascis, L. Di Paola, D. Barba, Reverse osmosis membranes for treatment of produced water: A process analysis, *Desalin. Water Treat.* 55 (2015) 565–574.
- [10] M.C. Annesini, V. Piemonte, M.C. Tomei, A.J. Daugulis, Analysis of the performance and criteria for rational design of a sequencing batch reactor for xenobiotic removal, *Chem. Eng. J.* 235 (2014) 167–175.
- [11] M.C. Tomei, M.C. Annesini, V. Piemonte, G.P. Prpich, A.J. Daugulis, Two phase reactors applied to the removal of substituted phenols: Comparison between liquid-liquid and liquid-solid systems, *Water Sci. Technol.* 62 (2010) 776–782.
- [12] M.C. Tomei, M.C. Annesini, Biodegradation of phenolic mixtures in a sequencing batch reactor, *Environ. Sci. Pollut. Res.* 15 (2008) 188–195.
- [13] L.D. Collins, A.J. Daugulis, Benzene/toluene/p-xylene degradation. Part I. Solvent selection and toluene degradation in a two-phase partitioning bioreactor, *Appl. Microbiol. Biotechnol.* 52 (1999) 354–359.